

W E R K Z E U G E

PREMIUM-WERKZEUGE

KS TOOLS

PREMIUM TOOLS



517.0043



Combination spanners set, offset, 6-32 mm

- flankTraction profile
- jaw 15° offset
- ring head 15° offset
- polished heads
- matt finish



21
-pcs



109,50 €

517.1595



Combination spanner set, extra long, 34-46 mm

- flankTraction profile
- execution similar to DIN 3113
- jaw 15° offset
- ring head 15° offset
- matt finish

4
-tlg.



399,90 €

518.0830



CHROMEplus Double ring spanner set, extra long

- flankTraction profile
- thin walled
- mirror polished
- chrome molybdenum

7
-tlg.



147,90 €

917.0216 PREMIUM-WERKZEUGE
KSTOOLS
PREMIUM TOOLS

1/4"+3/8"+1/2" Socket set

- 6 point
- flankTraction profile
- matt finish
- chrome vanadium
- in durable plastic storage case

216
-pcs

1/4" 3/8" 1/2"



174,90 €

1/4"			4 - 4,5 - 5 - 5,5 - 6 - 7 - 8 - 9 - 10 - 11 - 12 - 13 - 14 mm
1/4"			6 - 7 - 8 - 9 - 10 - 11 - 12 - 13 - 14 - 15 mm
1/4"			
3/8"			10 - 11 - 12 - 13 - 14 - 15 - 16 - 17 - 18 - 19 mm
3/8"			10 - 11 - 12 - 13 - 14 - 15 mm
1/2"			10 - 11 - 12 - 13 - 14 - 15 - 17 - 18 - 19 - 20 - 21 - 22 - 24 - 27 - 30 - 32 mm
1/2"			17 - 19 - 22 mm
1/2"			
1/4" 5/16"			
12x			8 - 9 - 10 - 11 - 12 - 13 - 14 - 15 - 16 - 17 - 18 - 19 mm



917.0728 PREMIUM-WERKZEUGE
KSTOOLS
PREMIUM TOOLS

1/2" socket set

- 6 point
- flankTraction profile
- matt finish
- chrome vanadium
- in durable plastic storage case

28
-pcs

1/2"



18x			10 - 11 - 12 - 13 - 14 - 15 - 16 - 17 - 18 - 19 - 20 - 21 - 22 - 23 - 24 - 27 - 30 - 32 mm
2x			16 - 21 mm
1x			1/2"
2x			125 - 250 mm
1x			1/2"
1x			250 mm
3x			1,5 - 2 - 2,5 mm



99,90 €



1/4"

3/8"

1/2"

917.0779

KS TOOLS
PREMIUM WERKZEUGE
PREMIUM TOOLS

179
-pcs



1/4"+3/8"+1/2" Socket set

- 6 point
- flankTraction profile
- matt finish
- chrome vanadium
- in durable plastic storage case

5°

72

96,50
€

1/4"		4 - 4,5 - 5 - 5,5 - 6 - 7 - 8 - 9 - 10 11 - 12 - 13 - 14 mm
		4 - 5 - 6 - 7 - 8 - 9 - 10 mm
		E4 - E5 - E6 - E7 - E8
3/8"		10 - 11 - 12 - 13 - 14 - 15 - 16 17 - 18 - 19 mm
		10 - 11 - 12 - 13 - 14 - 15 mm
		E10 - E11 - E12 - E14 - E16 - E1
1/2"		10 - 11 - 12 - 13 - 14 - 15 - 16 - 17 - 18 - 19 - 20 - 21 - 22 - 24 - 27 - 30 - 32 mm
		16 - 17 - 18 - 19 - 22 mm
		E20 - E24
1/4" 5/16"		⊖ ⊕ ⊗ ⊘ ⊙ ⊚
1/4" - 3/8" 1/2"		50 - 100 - 125 - 150 - 250 mm
1/4" 5/16"		1,3 - 1,5 - 2 - 2,5 - 3 - 4 - 5 mm



911.0721

KS TOOLS
PREMIUM WERKZEUGE
PREMIUM TOOLS

3/4" Socket set, 6 point



- 6 point
- flankTraction profile
- matt finish
- chrome vanadium
- in durable plastic storage case

3/4"



21
-pcs



16x		19 - 21 - 22 - 23 - 24 - 26 - 27 - 29 - 30 32 - 35 - 36 - 38 - 41 - 46 - 50 mm
3x		100 - 200 - 400 mm
1x		450 mm
1x		500 mm



219,90
€



- square drive adaptor to DIN 3120 / ISO 1174 with ball lock
- reversible
- very robust as a result of double pin technology
- extremely slim head
- ergonomic 2-component handle with a soft zone

935.1490 PREMIUM-WERKZEUGE KSTOOLS PREMIUM TOOLS

1/4" Monster reversible ratchet, 80 teeth

1/4" 106 g 125 mm



80 \times 4.5°

29,90 €

>110 Nm

935.1495 PREMIUM-WERKZEUGE KSTOOLS PREMIUM TOOLS

1/4" Monster bit reversing ratchet, 80 teeth

1/4" 106 g 125 mm



80 \times 4.5°

29,90 €

>110 Nm

935.3890 PREMIUM-WERKZEUGE KSTOOLS PREMIUM TOOLS

3/8" Monster reversible ratchet, 96 teeth

3/8" 227 g 199 mm



96 \times 3.75°

>365 Nm

39,90 €



935.1290 PREMIUM-WERKZEUGE KSTOOLS PREMIUM TOOLS

1/2" Monster reversible ratchet, 100 teeth

1/2" 567 g 275 mm



100 \times 3.6°

>950 Nm

49,90 €

935.1295 PREMIUM-WERKZEUGE KSTOOLS PREMIUM TOOLS

1/2" Monster reversible ratchet, long, 100 teeth

1/2" 757 g 425 mm



100 \times 3.6°

>950 Nm

69,90 €

935.1285 PREMIUM-WERKZEUGE KSTOOLS PREMIUM TOOLS

1/2" Monster Telescopic reversible ratchet, 100 teeth

1/2" 1.280 g 406 - 635 mm



100 \times 3.6°

>950 Nm

99,90 €

ADJUSTABLE

406 431 457 482 508 533 557 582 607 635 mm



ERGOTORQUE® precision torque wrench with rotary mushroom ratchet head

- actuation accuracy: $\pm 3\%$ tolerance of the set scale value
- precise reading accuracy for a minimum 5.000 tightening cycles
- for controlled fastening in clockwise and counter clockwise directions
- an audible and palpable signal when the desired torque value is achieved
- torque setting is quick and easy using the locking knob in the handle end

1/2" 3/4"

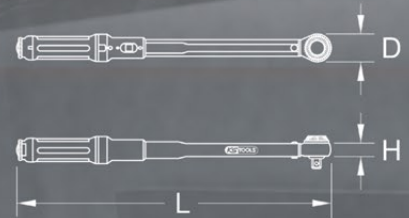
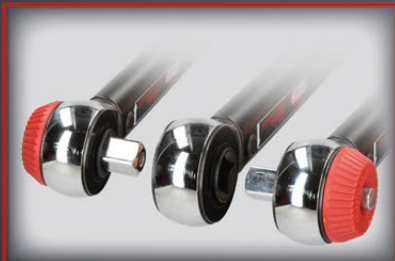
ERGOTORQUE® PRECISION



PREMIUM WERKZEUGE KS TOOLS PREMIUM TOOLS		■	L mm	D mm	H mm	Nm	Division Nm	Lbf-ft	€
516.1442		1/2"	500,0	45,0	23,0	40-200	1.0	15-150	110,90
516.1482		1/2"	678,0	45,0	23,0	80-420	1.0	60-310	135,90
516.1493		3/4"	1250,0	69,0	33,0	150-750	10.0	150-550	588,90

516.1499



Rotary square box wrench, 3/4"

- enables quick pre-fastening of the screw connections, especially in constrained spaces
- simple to be used in place of the standard box wrench
- square drive adaptor to DIN 3120 / ISO 1174 with ball lock

3/4"

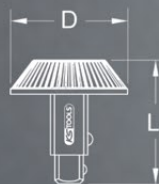

■	■	D mm	L Nm
3/4"	3/4"	63,0	73,0



39,50 €





66,50 €

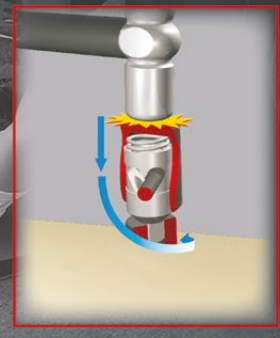

1/2" 5/16"

515.1000



1/2" handheld impact screwdriver set

- reversible
- 1/4 Revolution of the impact screwdriver through hammer blow (Parable mechanism)
- no slippage of the blade bit possible
- ideal for loosening jammed screw connections
- ideally suited for the automotive area

18 -pcs



1x		1/2"	2x		M8 - M10
1x		1/2"x 5/16"	3x		PH1 - PH2 - PH3
2x		T30 - T40	6x		5 - 6 - 8 - 10 - 12 - 14 mm
3x		5 - 6 - 8 mm			

151.1150



ERGOTORQUEmax hammer cap screwdriver set

- hexagon drive
- includes T-handle ratchet
- protective cap on the handle end
- optimal power transmission
- hardened blade



13 -pcs



67,90 €

5x		3,5 - 5,5 - 7 - 8 - 10 mm
5x		PH0 - PH1 - PH2 - PH3 - PH4
1x		6 mm
1x		PH2
1x		1/4"

150.9625



Hand rivetting tool, 315 mm

- suitable for blind rivets
- including five interchangeable mouthpieces
- no tool necessary to change the mouthpieces
- low effort due to innovative lever technology
- with collecting container for rivet mandrel

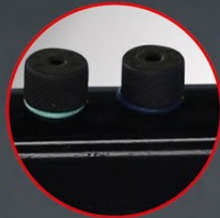

max. Rivet -Ø mm	L1 mm	L2 mm	D Nm
6,4	315,0	40,0	23,0



Blind rivets, aluminium: 2,4 - 3,2 - 4,0 - 4,8 - 6,4 mm

Blind rivets, steel: 2,4 - 3,2 - 4,0 - 4,8 mm



27,90 €

Water pump pliers

- with accurate industrial adjustment
- with safety clamping protection
- optimum power transfer
- asymmetric grip profile with offset teeth
- with PVC dipped handle

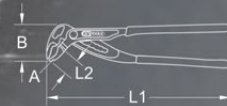

KS TOOLS PREMIUM WERKZEUGE		A mm	B mm	L1 mm	L2 mm	€
115.2011		35,0	38,0	175,0	20,0	10,90
115.2010		45,0	47,0	240,0	25,0	12,90
115.2012		55,0	53,0	300,0	30,0	15,90

115.2016



Water pump pliers, 415 mm

- with accurate industrial adjustment
- with safety clamping protection
- optimum power transfer
- asymmetric grip profile with offset teeth
- with PVC dipped handle



A mm	B mm	L1 mm	L2 Nm
90,0	80,0	415,0	30,0



31,90 €



500.1350



Circlip pliers set with ratchet function

- for inside and outside circlips
- 8 types of pliers by reversing the tips
- includes disassembly and assembly heads

Internal circlips: 60,0 mm - 100,0 mm
 External circlips: 40,0 mm - 85,0 mm

6 x



20
-pcs



49,90 €

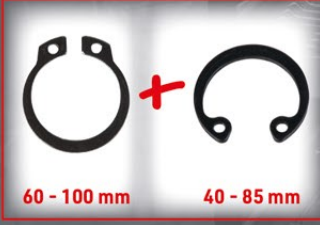

500.7220



Precision tool set

- including precision mechanics screwdrivers and pliers
- suitable for wire
- serrated execution
- induction-hardened precision cutting
- self opening double spring
- twist end cap
- ergonomically shaped electronic screwdriver handle
- hardened blade
- chrome finish with burnished surface
- two component handle
- black chrome
- blade made of chrome vanadium
- with practical carrying bag

10
-pcs

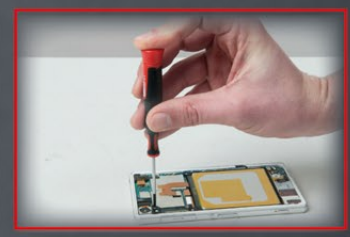
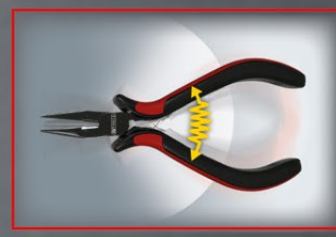

24,90 €

1x		120 mm	3x			PH00 - PH0 - PH1
1x		120 mm	3x			2,0 - 2,4 - 3,0 mm
1x		120 mm				
1x		160 mm				

150.1765

KSTOOLS
PREMIUM TOOLS

Automatic digital multimeter incl. test probes

- automatic identification of AC voltage, DC voltage, resistance
- testing of live cable
- non-contact induction voltage test
- large 3.5" colour LCD display
- test lead set with test tip (red/black)
- 700 mAh lithium-ion battery included
- robust protective cover included
- with practical carrying bag

Functions:

- DC and AC voltage measurement
- resistance measurement
- capacitance measurement
- frequency measurement
- diode testing
- induction voltage measurement
- cable test
- work light

Technical data:

Capacity measurement:	1 nF - 99,99 mF
DC voltage:	0,8 V - 620 V
AC voltage:	2,2 V - 620 V
Resistance measurement:	1 Ohm - 60 MOhm
Frequency measuring:	1 Hz - 60 KHz
Storage temperature:	-10° to +40° C (14° to 104° F)
Working temperature:	-10° to +60° C (14° to 140° F)



49,90 €



67,90 €



550.1285

KSTOOLS
PREMIUM TOOLS

Refractometer-optical tester for battery fluid, antifreeze and AdBlue® additives

- for the quick and accurate testing of the acidity of the battery fluid, the antifreeze content and the AdBlue® additives
- can also be used for coolant and windscreen wiper fluid
- also suitable in ambient temperatures of less than 10°C
- high quality design made from aluminium

*AdBlue® is a registered trademark of the Verband der Automobilindustrie e.V. (VDA).

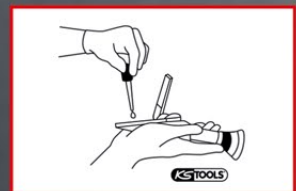

D	L	Glass surface
mm	mm	mm
40,0	160,0	40 x 13

670.0131



Universal ball joint separator, 36 mm

- for separating the ball plug when removing the ball joints
- suitable for many vehicles + moderately heavy trucks
- special tool steel

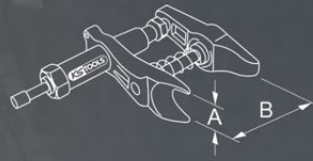

160,50 €



A mm	B mm	max t	mm	mm
36	90	10	22	G1/2"x14gx110

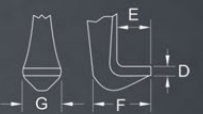
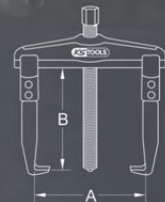
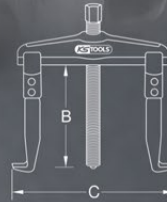

Universal 2 + 3 arm puller

- legs double ended usable
- through reversing the arms internal and external applications are possible
- reception star for 2 or 3 hooks
- extremely robust spindle with inductively hardened thread
- special tool steel

		A mm	B mm	C mm	max. t	mm	mm	D mm	E mm	F mm	G mm	€
640.4203		60	65	90	2,0	G3/8"x1,06px110	13	3	10	18	11	58,90
640.4204		90	100	135	5,0	G9/16"x2,0px190	17	4	15,5	29	17	102,90
640.4205		165	170	170	7,0	G3/4"x2,0px285	22	4	15,5	29	17	133,90



1,34
KG

1/2"

1.390
Nm



515.1270



1/2" miniMONSTER High Performance Pneumatic impact wrench 1.390 Nm

- with non slip soft grip handle
- air exhaust through the handle
- with practical clockwise and anticlockwise switch
- easy operation
- 3 stage torque adjustment
- high performance industrial jumbo mechanism
- long service life
- cold insulated handle
- includes 1/4" coupling connector
- ultra light aluminium housing

Technical data:

Square drive:	1/2"
max. Tightening torque:	1 = 270 Nm
	2 = 640 Nm
	3 = 965 Nm
	1390 Nm
max. Loosening torque:	10000
No Load current rpm:	< 9,18 m/s ²
Vibration acceleration:	113
Noise pressure level (dbA):	102
Noise pressure level (dbA):	615 Nm
Reccomended torque:	135
Air consumption in U/min:	max. 6,3 bar
Operating pressure in bar:	M 16
max. Screw size:	3/8" - 10 mm
min. Tube diameter:	1/4"PT
Connection thread:	



149,90
€

515.1210



1/2" MONSTER High Performance Pneumatic impact wrench, 1.690 Nm

- with non slip soft grip handle
- air exhaust through the handle
- with practical clockwise and anticlockwise switch
- easy operation
- 3 stage torque adjustment
- high performance double hammer mechanism
- long service life
- cold insulated handle
- includes 1/4" coupling connector
- ultra light aluminium housing

2,15
KG

1/2"

1.690
Nm



Technical data:

Square drive:	1/2"
max. Tightening torque:	1 = 510 Nm
	2 = 680 Nm
	3 = 931 Nm
	1690 Nm
max. Loosening torque:	7930
No Load current rpm:	< 17,9 m/s ²
Vibration acceleration:	98
Noise performance level (dbA):	87
Noise pressure level (dbA):	542 Nm
Reccomended torque:	178
Air consumption in U/min:	max. 6,3 bar
Operating pressure in bar:	1/2" - 12,7 mm
min. Tube diameter:	1/4"PT
Connection thread:	



149,90
€



superMONSTER high performance impact wrench

- with non slip soft grip handle
- air exhaust through the handle
- with four-stage torque adjustment for tightening and loosening
- easy operation
- low vibration
- air exhaust integrated in the handle
- low sound level
- high performance double hammer mechanism
- including bore hole for locking pin
- long service life
- cold insulated handle
- includes 1/2" coupling connector
- ultra light aluminium housing

Technical data:

Material: aluminium
 Noise performance level (dba): 104,5
 Noise pressure level (dba): 115,5
 max. Loosening torque: 3405 Nm
 Vibration acceleration: < 12,88 m/s²
 Measuring uncertainty: 1.77
 vibration acceleration: 283
 Air consumption in U/min: 6200
 No Load current rpm: max. 6,3 bar (90 psi)
 Operating pressure in bar: pneumatic
 Operating Mode: 1 = 919 Nm
 max. Tightening torque: 2 = 1523 Nm
 3 = 2145 Nm
 4 = 3064 Nm
 3/4" - 19 mm
 M 38
 1/2" PT
 non-slip soft grip handle

min. Tube diameter:
 max. Screw size:
 Connection thread:
 Handle:



KSTOOLS PREMIUM WERKZEUGE PREMIUM TOOLS	QR	□	B mm	L mm	Nm	kg	€
515.3250		3/4"	230	350	3.405	6,70	849,90
515.3270		1"	230	350	3.405	6,75	849,90

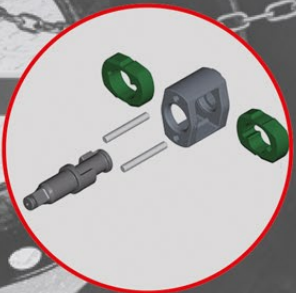

KSTOOLS PREMIUM WERKZEUGE PREMIUM TOOLS	QR	□	B mm	L mm	Nm	kg	€
515.3260		3/4"	230	504	3.405	7,76	904,90
515.3280		1"	230	504	3.405	7,82	904,90

515.1915



Pneumatic blow out pistol, long

- with 90° side nozzle and Venturi nozzle
- ideal for cleaning and removing of foreign objects also in hard to reach places
- grip area with insulated lance to protect it from cold
- controllable air volume
- direct air coupling suitable for connection

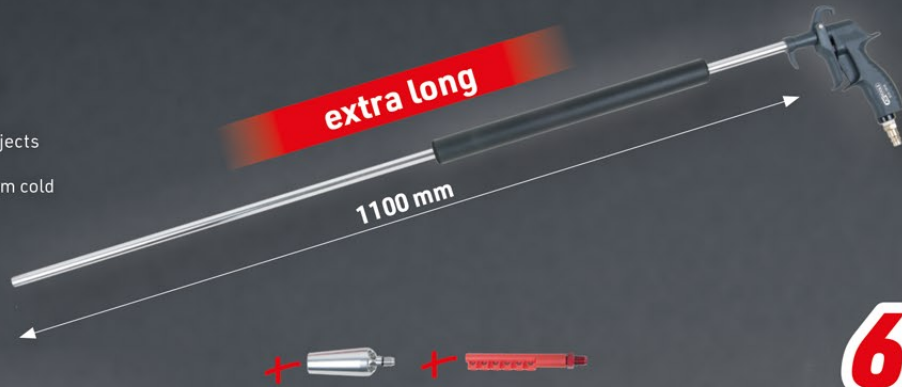

3
-pcs



69,90 €



300 mm **960 mm** **456 mm**





99,90 €

800.0960

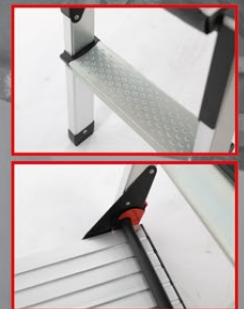

Aluminium work platform

- skid proof profile on the platform stage
- large platform for safe standing
- the gripped plastic feet protect the surface and add stability



150.4490



Mobile workshop hand lamp, foldable, 550 lumen

- ideal for very long network independent working
- 10 Watt COB LED + 1 x 5 Watt LED Head light
- steplessly dimmable
- with USB power bank function (charging of external devices)
- heat dissipation through cooling fins on the rear
- with control LED to discharge
- 360° foldaway magnetic stand
- includes automatic turn off charging station
- optionally direct charging at the lamp
- including USB C charging cable
- with belt clip and hook
- weatherproof protection IP64
- shock and impact resistant
- 3 hours charging time
- 3.5 hours lamp duration
- impact resistant Polycarbonate housing
- housing body covered with high quality rubber



37,50 €



156.0020



Pin punch set with hand protection grip, 6-14 mm

- quenched and tempered
- tip can be re-sharpened
- burnished
- chrome vanadium
- in metal stand with the possibility of wall hanging

5
-pcs



92,50 €

5 x Pin punch: 6 x 270 - 8 x 300 - 10 x 300 - 12 x 300 - 14 x 300 mm



Telescopic flexible roll head pry bar

- lever extension with push-button in steps
- roller head adjustable in steps
- extra narrow, with recessed push button
- maximum power transmission in the narrowest area
- ideally suitable for passenger cars to commercial vehicles

KSTOOLS PREMIUM WERKZEUGE PREMIUM TOOLS	QR	L mm	H mm	B mm	€
911.8186		325 - 460	90,0	12,0	69,50
911.8187		600 - 915	120,0	20,0	89,90
911.8188		865 - 1350	145,0	24,0	201,50

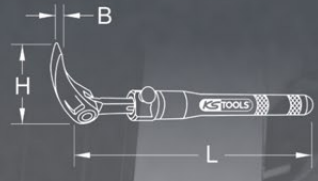

Special socket for Mercedes

- for loosening and tightening of the special screw connection of the vehicle body
- internal square drive to DIN 3121 / ISO 1174
- for machinery usage
- phosphate finish
- chrome molybdenum

Application range: Mercedes Bus (405), Unimog (437), Econic (956), Actros (963), Arocs (964), Atego (967), Zetros (949)



1/2" 3/4"

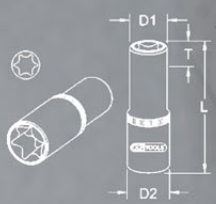

KSTOOLS PREMIUM WERKZEUGE PREMIUM TOOLS	QR	Size	Model	L mm	D1 mm	D2 mm	T mm	€
460.0014		3/4"	E30	111,0	38,0	38,0	31,0	22,90
460.0016		1/2"	E30	46,0	34,0	30,0	30,0	14,90



460.1180



Hydraulic transmission jack with adjustable pickup plate, 1 t

- ideal for safe removal and installation of gearboxes
- uncomplicated lifting by hydraulic hand pump
- continuous adjustment allows for precise positioning
- especially wide working area
- controlled lowering of the load possible

1.599,00 €



max. Load capacity kg	Lift height min. mm	Lift height max. mm	Total Length mm	Width in mm
1000	300,0	750,0	910,0	480,0

150.2450



Universal commercial vehicle clutch aligner tool set

- universal usage for vehicles with a hub diameter of \varnothing 36.0 - 52.0 mm
- sturdy design
- for the professional and quick assembly of single and two-disc dry clutches
- for vans and small lorries



200,50 €



Torx-E-Plus socket for Mercedes, 32 EPL

- torx-E-Plus (EPL)
- for loosening and tightening Torx-E-Plus (EPL) axle mounting bolts
- for machinery usage
- chrome molybdenum

Application range: Mercedes Actros

3/4"

Mercedes Actros

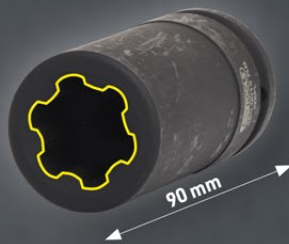
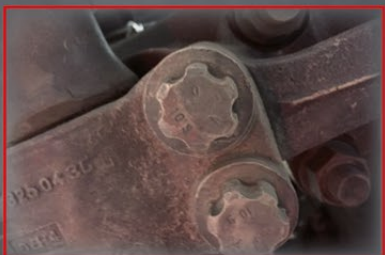

KS TOOLS PREMIUM WERKZEUGE PREMIUM TOOLS	QR	3/4"		D mm	L mm	€
460.0012	QR	3/4"	EPL 32	44,0	50,0	27,90
460.0013	QR	3/4"	EPL 32	44,0	90,0	37,90

460.1765



Universal commercial vehicle wheel hub extractor set

- variable use for bolt circle diameter 110 mm - 448 mm
- universal use for bolts up to max. Ø 30 mm
- with 2 rods and trapezoid thread spindle
- with 3 pressure pieces
- includes 5 thread adaptor sets

Application range: Sauer, BPW, Scania, Fuso, Hino

UNIVERSAL Sauer, BPW, Scania, Fuso, Hino

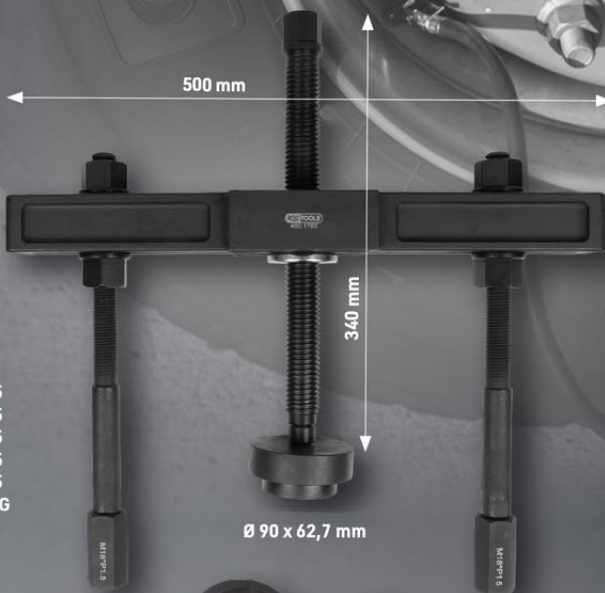

- 2 x M18 x 1,5
- 2 x M20 x 1,5
- 2 x M22 x 1,5
- 2 x M24 x 1,5
- 2 x M30 x 1,5
- 2 x 7/8" x 11G

27 pcs

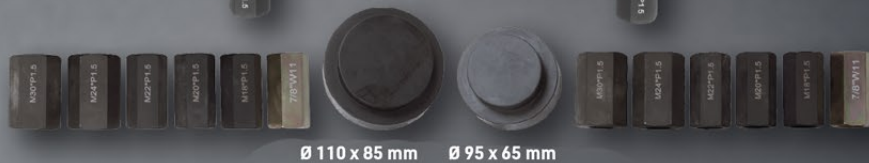

1.102,50 €

460.3620



Axle post press, 75 t, with sleeve set

- suitable for quick insertion and removal of king pins
- press unit is 360° rotatable
- swivelling, rotatable and with height adjustment for components that are difficult to access
- including pneumatic hydraulic foot pump with quick lift, hydraulic cylinder, most common sleeves and pressure pieces
- time- and cost-efficient



Technical data:

Capacity:	75 t
Stroke mm:	160,0
Open width:	260 mm
Operating pressure max (bar):	700
Volume in litre:	1,8



4.449,90
€





450.0190



Vario nut and key set

- for the dismantling and assembly of vario nuts
- suitable for exact torque with a 3/4" square drive
- certain stop through clamping screws and adapter guides on the basic device
- hole separation maximum 145 mm
- includes clamping chain

Application range: 6 point-, 8 point-, Nuts- and round nuts

700 Nm



14 - pcs



529,90 €

450.0175



3/4" Groove nut wrench with guide tube, MAN TGA

- high accuracy of fit
- extremely robust version
- optional with locating tube
- suitable for high tightening and loosening torque

Application range: MAN TGA rear axle, HY-1350 (Hypoid)



MAN TGA



326,50 €

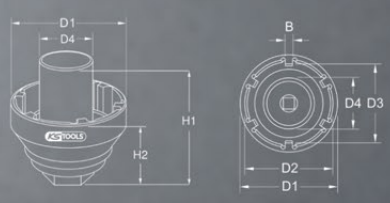

mm	H1 mm	H2 mm	D1 mm	D2 mm	D3 mm	Studs	B mm
60	160,0	98,0	148,0	133,0	117,0	6	11,5

450.0201



Axle nut wrench for SAF, 85 mm, Ø 118 mm

- positive drive of the axle nut
- any extensive slipping is avoided
- milled out profile
- can be used with an impact wrench or torque wrench

Application range: SAF axle trailers

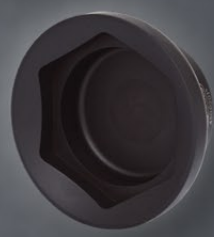
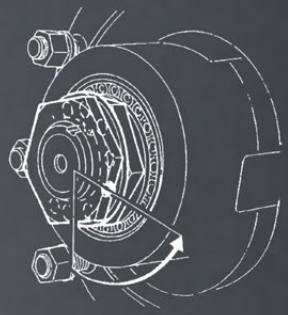

mm	mm	Ø mm	Height mm
85,0	36,0	118,0	82,0

179,90 €

150.1430



**Thread repairer for external thread
Ø 25-140 mm**

- for re-cutting and cleaning damaged outer threads Ø 25 - 140 mm
- very large application range due to 6 supplied plates
- no damage of the thread due to the soft holding guides
- suitable for right and left-handed thread
- can be used everywhere regardless of the thread length

Metric: 1.0 - 1.25 - 1.5 - 1.75 - 2.0 - 2.5 - 3.0 - 3.5 mm
Imperial: 24 - 20 - 18 - 16 - 14 - 12 - 11,5 - 11 - 10 - 9 - 8 - 7,5 - 7 - 6 - 5 - 4 pitch/imperial



187,50
€



460.4720



Calliper repair case set

- for the professional repair of callipers
- for the replacement of bellows, calliper bearings and the internal sealing of the bellow
- secure and easy to use
- sturdy design
- enormous time and cost saving

Application range: Knorr (SB, SN and SK), Wabco (PAN 19-1 and PAN 22-1), Haldex Modul T (SAF, SBS2220 H0)



1.055,50
€

36
-pcs



450.0340



**Reamer for ABS sensors for
commercial vehicle Ø 18x45 mm**

- for cleaning the mounting bore of the ABS sensors
- for a correct and damage free assembly of the new sensor
- with fixable joint and ratchet function
- for working in hard to access areas



181,90
€



460.2615



**Brake piston special socket wrench set for
WABCO and Knorr disk brakes**

- ideal for pushing back the brake piston damage-free
- allows for safe and comfortable working
- whilst carrying out maintenance work and when changing the brake pads it is necessary to lead the brake pistons back into the brake calliper
- high precision guarantees an easy and durable use
- saves a lot of time

5
-pcs

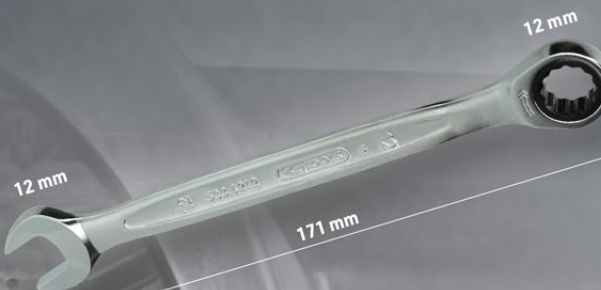

SAF



39,50
€

Ø	L1	L2
18,0	150,0	45,0



440.0585



Hydraulic unit 32 t, with hydraulic pump and manometer

- optimal for universal use in car garages
- includes hydraulic pump and manometer
- suitable for both pressure and train uses
- with magnetic centring adapter
- pressure of the hydraulic cylinders can be combined with the impact body with impact force during use

11 -pcs



2.182,90 €



440.0590



Wheel hub puller set for 8 and 10 bolts

- for disassembly of truck wheel hubs with 8 or 10 bolts (275 mm / 335 mm)
- use in conjunction with 32t hydraulic cylinder (440.0025) with impact function
- ideal for pressing out wheel hub with compact bearing
- sturdy design
- secure and easy to use

Recommended hydraulic cylinder: 32 t (440.0025)

11 -pcs



1.332,50 €





1/2"

460.5062



1/2" impact 12-sided wrench with 2 impact surfaces, 24 mm

- 12 point
- ideal for simple loosening and tightening of the brake cylinder screw connections
- this means that the dismantling does not apply
- with 1/2" square drive for correct tensioning of the screw connection



65,50 €

mm	A mm	B mm	Total length mm
24	12,0	39,0	207,0



911.3463



3/4" Bit socket hexagon, long, 14 mm

- hexagon socket
- in accordance with DIN 7422
- internal square drive to DIN 3120 / ISO 1174 with ball reception
- long execution
- also ideally suited for the assembly and disassembly of commercial vehicle brake calipers
- with press-fitted nickel-plated bit
- for manual operation
- matt finish
- chrome vanadium



24,90 €

3/4"

mm	D mm	L mm	T mm
14,0	38,0	155,0	100,0

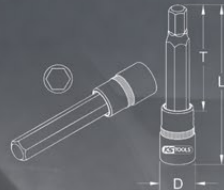

150.1995



Hub nut pliers, 250 mm

- with PVC dipped handle
- for removing of wheel nut caps
- no slipping through specially coated jaws
- ideally suited for commercial vehicles
- special tool steel

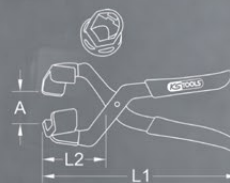

A mm	L1 mm	L2 mm
28,0-60,0	250,0	72,0

24,90 €



160.0250



Commercial vehicle wheel lifter, 250 kg

- easy and flexible transport even in small rooms
- for effortless collection and transport of tyres and rims
- ideal for changing truck, bus and fork lift tyres
- triple adjustable tyre sizes
- perfect for tyre shops, garages and forwarding agents



Technical data:

Wheel carrier length:	220,0 mm
Effective stroke:	100,0 mm
Highest weight of the wheel:	250 kg
Reception of tyre:	6,5" - 22,5"
Smallest diameter of the wheel:	600,0 mm
Largest diameter of the wheel:	1100,0 mm
max. Clamping width:	620,0 mm
Average clamping width:	450,0 mm
Minimum clamping width:	290,0 mm

269,90
€



max.
250 kg

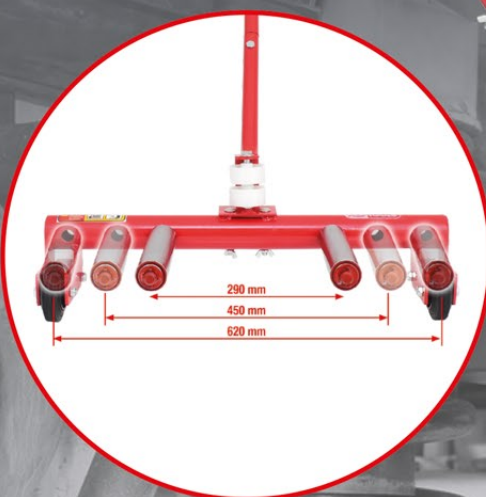

160.0739



Pneumatic hydraulic trolley jack

- hydraulic jack for vehicles up to max. 30 t
- short and compact design
- extremely light weight ideal for the mobile usage
- overload protection through overload pressure valve
- suitable for narrow spaces

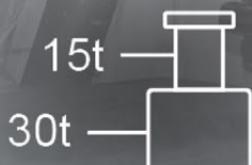

1.487,50
€



max. Capacity t	L mm	L2 mm	L3 mm	L4 mm	L5 mm
30 / 15	430,0	150,0	139,0	75,0	45,0



810.7397

Performanceplus workshop tool trolley set P10 with 397 tools for 7 drawer

- stainless steel worktop
- ABS border with compartments for small parts
- very stable steel construction with 0,8 mm sheet steel - distortion resistant
- high level of stability
- side walls with metal peg board for mounting different accessories
- handle locking system prevents unintentional opening
- central locking system on all drawers through the cylinder lock
- ball bearing drawer runners
- with polyurethan corner protection
- drawers are 100% extendable
- full width metal handle
- two fixed wheels Ø 125 mm
- two castor wheels Ø 125 mm with rolling and turning brake
- side mounted handle
- electrostatic powder coating



Performance plus



Dual Lock Brilliant
locking system

2.699,00 €

P10



41 Screwdriver set



111 1/4" + 3/8" + 1/2" socket spanner set

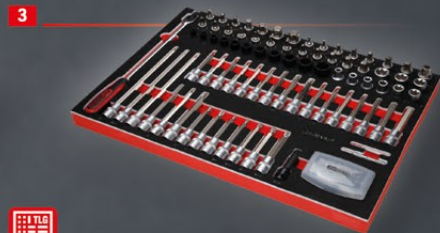

81 1/2" screwdriver bit set

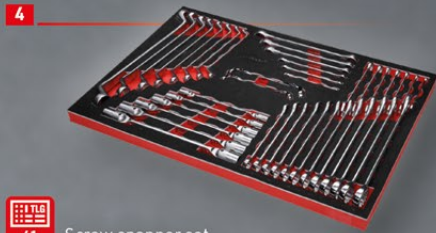

41 Screw spanner set



28 Pliers and file set



43 Oil and tyre servicing set

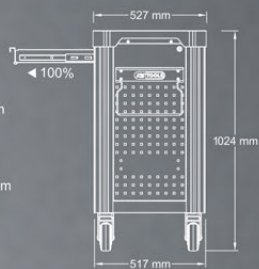
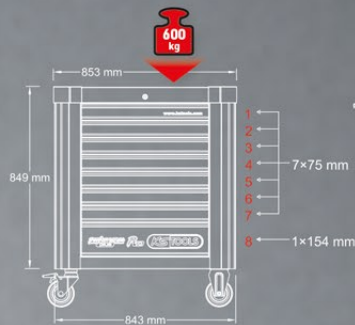

22 Hammer and chisel set

Your partner



KS Tools Werkzeuge - Maschinen GmbH

Seligenstädter Grund 10 - 12
D- 63150 Heusenstamm

Mail: aftersales@kstools.com
Web: www.kstools.com

GERMANY



Paper roll holder included



Can holder included



Stable ball bearing



Anti-static castors with brakes